

# T BEND – MANDREL BENDING MACHINES FULL ELECTRIC WITH CNC-CONTROL





## T BEND - MANDREL BENDING MACHINES FULL ELECTRIC WITH CNC-CONTROL

**For better efficiency.** The electric axes can be programmed in synchronicity to give optimum cycle times. Tools for bending on multiple levels with automated tool change makes it possible to achieve various radii and the most complex geometries on tubes.

With our clockwise/counterclockwise bending machines – also available with push bending function – the most complex bends become reality with great accuracy.

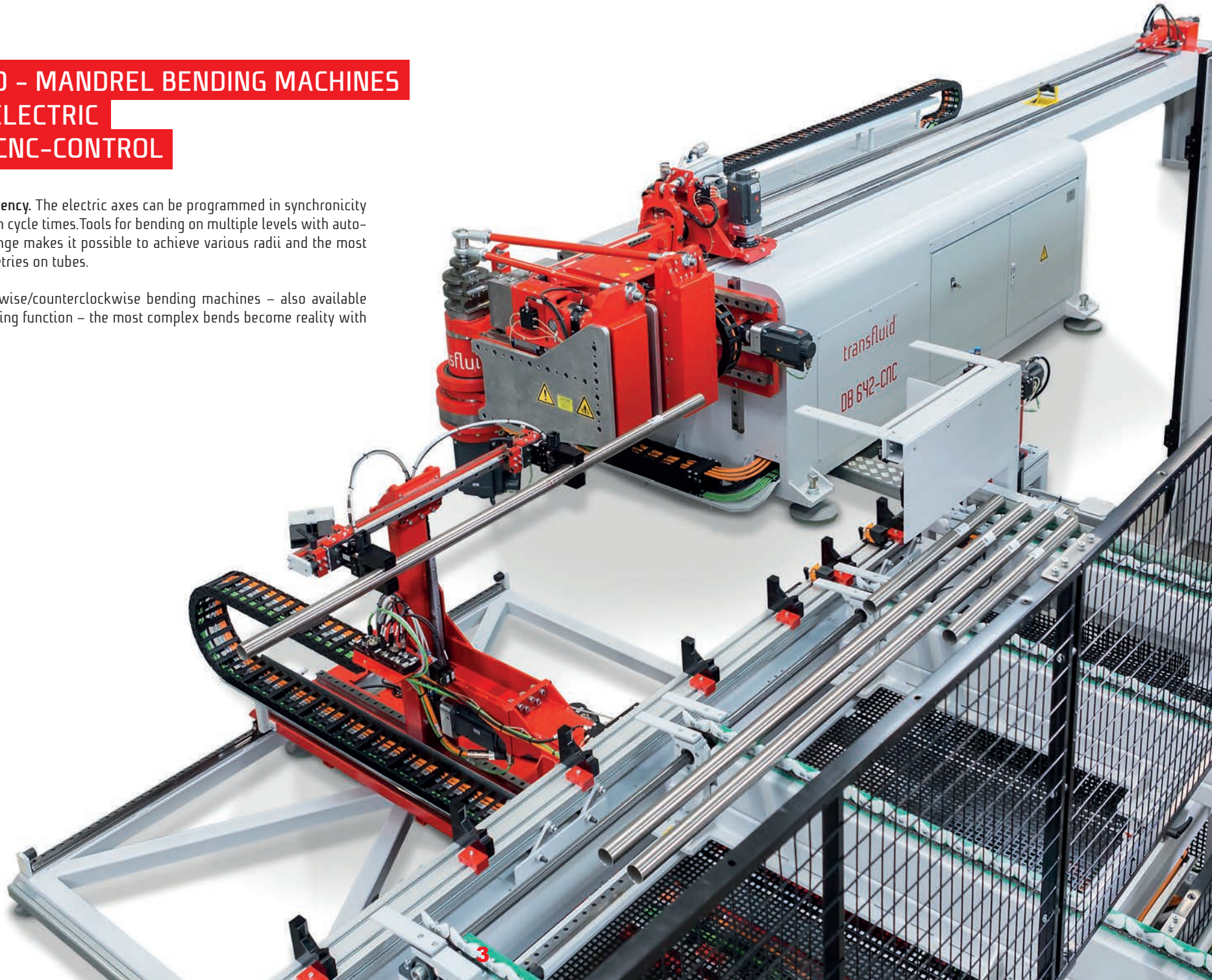

# T BEND - MANDREL BENDING MACHINES

## FULL ELECTRIC WITH CNC-CONTROL

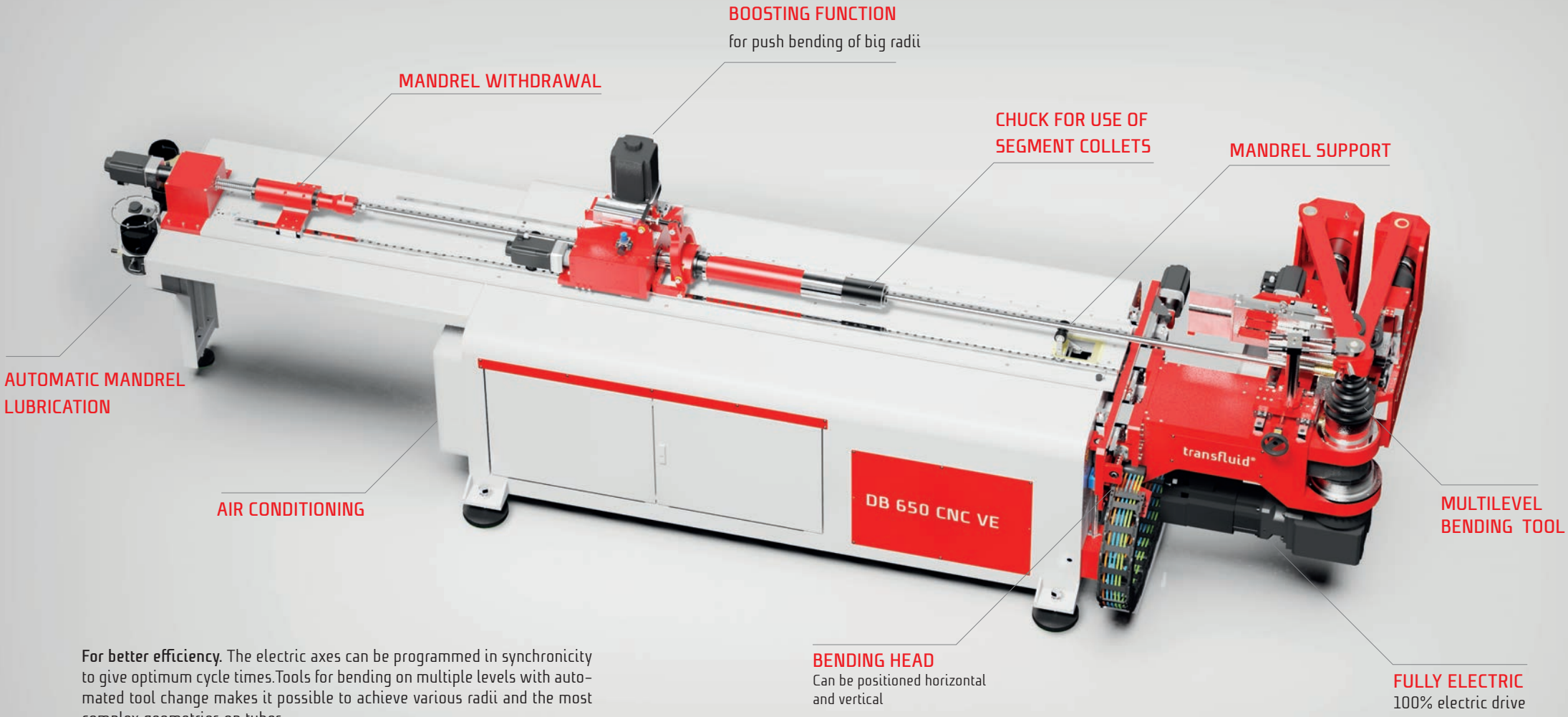

For better efficiency. The electric axes can be programmed in synchronicity to give optimum cycle times. Tools for bending on multiple levels with automated tool change makes it possible to achieve various radii and the most complex geometries on tubes.

## OUR PORTFOLIO OF MACHINES



Type	DB 622-CNC VE	DB 630-CNC VE	DB 642-CNC VE	DB 650-CNC VE
Max. capacity	22 x 2 mm (mild steel) 22 x 1,5 mm (stainless steel) 16 x 1,5 mm (square mild steel)	30 x 2 mm (mild steel) 30 x 1,5 mm (stainless steel) 20 x 2,5 mm (square mild steel)	42 x 3 mm (mild steel) 42 x 1,5 mm (stainless steel) 25 x 2,5 mm (square mild steel)	50,8 x 3 mm (mild steel) 50,8 x 2 mm (stainless steel) 35 x 35 x 4 mm (square mild steel)
Max. Radii	66 mm	90 mm	168 mm	150 mm
Usable length	2000 mm (standard) 3048 mm 4572 mm 6096 mm (special)	2000 mm (standard) 3048 mm 4572 mm 6096 mm (special)	2000 mm 3048 mm (standard) 4572 mm 6096 mm (special)	2000 mm 3048 mm (standard) 4572 mm 6096 mm (special)
Speed of bending axis	300 °/sec.	275 °/sec.	180 °/sec.	180 °/sec.
Number of CNC axes	9	9	9	9
Power bending axis	servo-electric	servo-electric	servo-electric	servo-electric
Operating voltage	400 Volt - 50 Cyl - 3 Ph. - 13 KW	400 Volt - 50 Cyl - 3 Ph. - 16 KW	400 Volt - 50 Cyl - 3 Ph. - 26 KW	400 Volt - 50 Cyl - 3 Ph. - 55 KW
Voltage of the control	24 Volt DC	24 Volt DC	24 Volt DC	24 Volt DC
Length	4750 mm	5000 mm	5800 mm	6150 mm
Width	1550 mm	1650 mm	1600 mm	1850 mm
Height	1450 mm	1450 mm	1450 mm	1650 mm
Weight approx.	2800 kg	3100 kg	3500 kg	4500 kg

# T BEND - MANDREL BENDING MACHINES

## FULL ELECTRIC WITH CNC-CONTROL

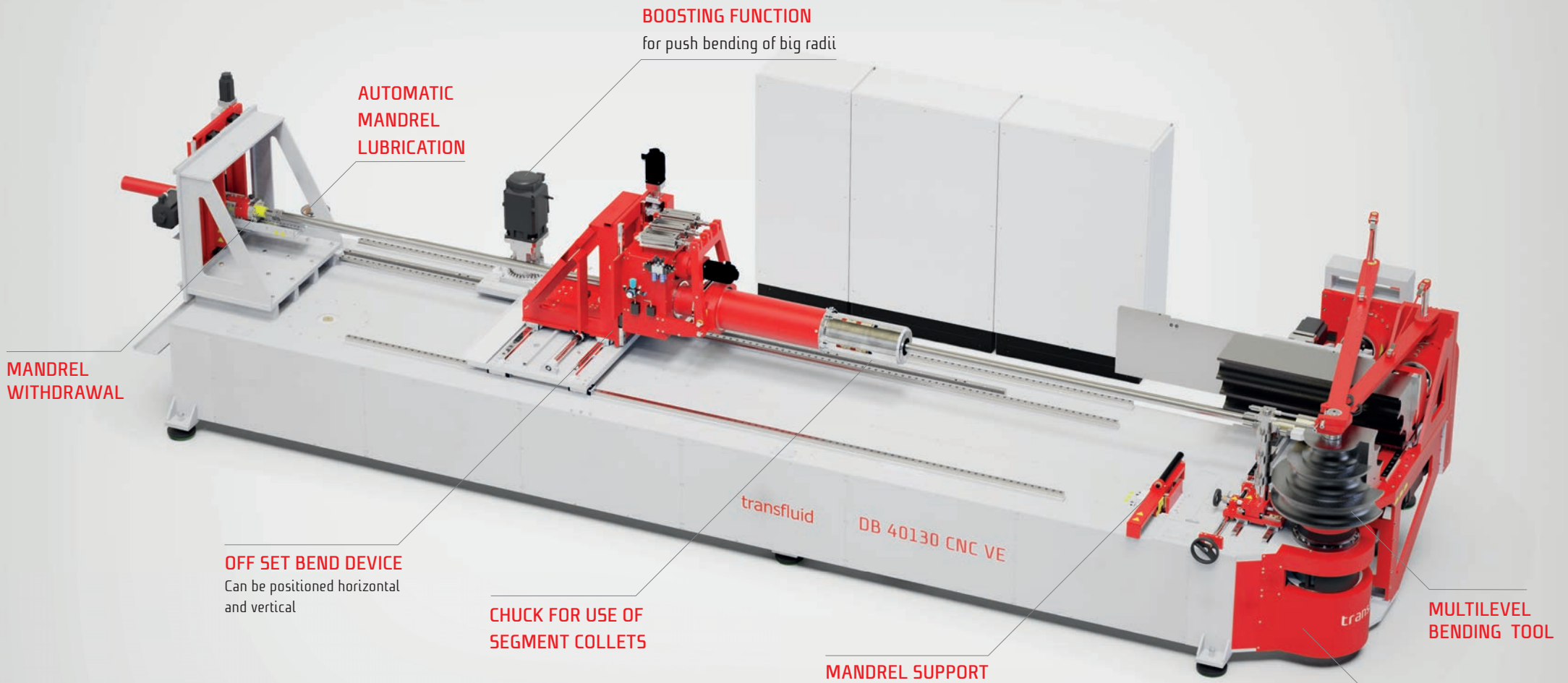

MANDREL  
WITHDRAWAL

AUTOMATIC  
MANDREL  
LUBRICATION

BOOSTING FUNCTION  
for push bending of big radii

OFF SET BEND DEVICE  
Can be positioned horizontal  
and vertical

CHUCK FOR USE OF  
SEGMENT COLLETS

MANDREL SUPPORT

MULTILEVEL  
BENDING TOOL

FULLY ELECTRIC  
100% electric drive

For better efficiency. The electric axes can be programmed in synchronicity to give optimum cycle times. Tools for bending on multiple levels with automated tool change makes it possible to achieve various radii and the most complex geometries on tubes.

## OUR PORTFOLIO OF MACHINES



Type	DB 2060-CNC VE	DB 2080-CNC VE	DB 20100-CNC VE	DB 40130-CNC VE	DB 40150-CNC VE
Max. capacity	63 x 2,0 mm (mild steel) 63 x 1,5 mm (stainless steel) 35 x 35 x 4 mm (square mild steel)	80 x 3mm (mild steel) 80 x 2 mm (stainless steel) 55 x 55 x 4,0 mm (square mild steel)	101,6 mm x 3 mm (mild steel) 101,6 mm x 3 mm (stainless steel) 70 x 70 x 4 mm (square mild steel)	130 x 3,0 mm (mild steel) 130 x 2,5 mm (stainless steel) 90 x 90 x 5,0 (square mild steel)	150 x 3,0 mm (mild steel) 150 x 2,5 mm (stainless steel) 90 x 90 x 5,0 mm (square mild steel)
Max. Radii	150 mm	240 mm	305 mm	390 mm	450 mm
Usable length	2000 mm 3048 mm (standard) 4572 mm 6096 mm (special)	3048 mm (standard)	3048 mm (standard)	4572 mm (standard) 6096 mm (special)	4572 mm (standard) 6096 mm (special)
Speed of bending axis	180 °/sec.	100 °/sec.	80 °/sec.	65 °/sec.	65 °/sec.
Number of CNC axes	9	9	9	9	9
Power bending axis	servo-electric	servo-electric	servo-electric	servo-electric	servo-electric
Operating voltage	400 Volt - 50 Cyl - 3 Ph. - 30 KW	400 Volt - 50 Cyl - 3 Ph. - 75 KW	400 Volt - 50 Cyl - 3 Ph. - 90 KW	400 Volt - 50 Cyl - 3 Ph. - 110 KW	400 Volt - 60 Cyl - 3 Ph. - ?? KW
Voltage of the control	24 Volt DC	24 Volt DC	24 Volt DC	24 Volt DC	24 Volt DC
Length	6700 mm	8150 mm	8244 mm	10000 mm	10000 mm
Width	1250 mm	2500 mm	2245 mm	3000 mm	3000 mm
Height	1400 mm	1900 mm	2125 mm	2000 mm	2000 mm
Weight approx.	3500 kg	10000 kg	16200 kg	15000 kg	15000 kg

## BASIC EQUIPMENT:

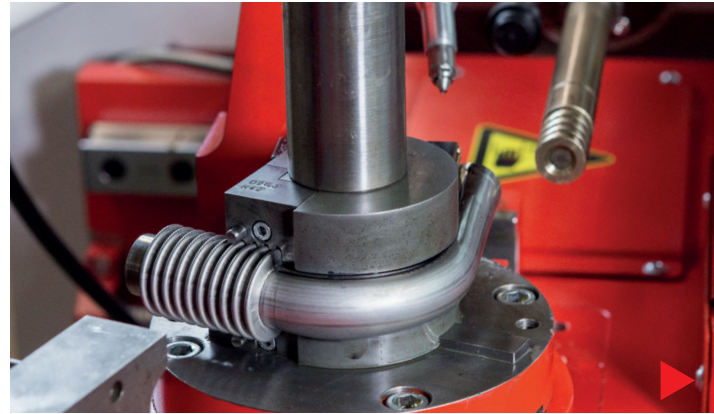

### CUSTOM BENDING TOOLS

Bending tools for tubes with already formed tube ends

### SOLID MATERIAL

Adaptation of the bending machine for bending busbars/ conductor rails/ flat conductors.

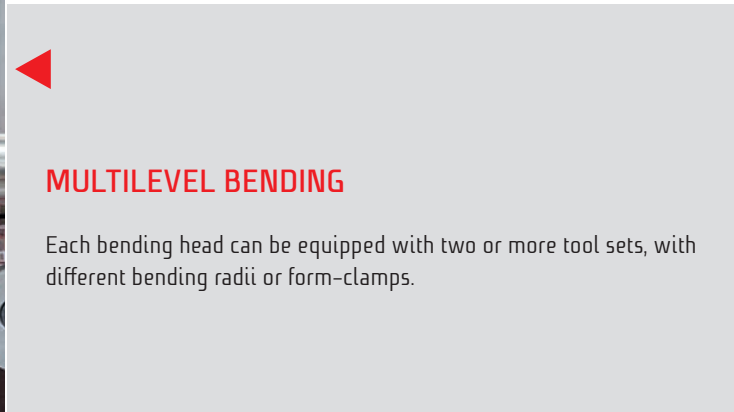

### MULTILEVEL BENDING

Each bending head can be equipped with two or more tool sets, with different bending radii or form-clamps.



### HOLLOW SHAFT

Allows small-bend-radius tooling.

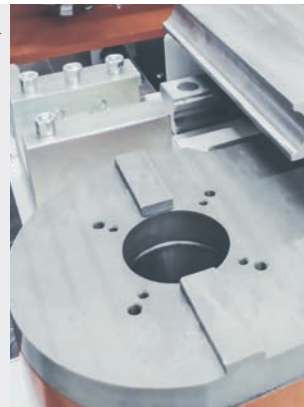



## BASIC EQUIPMENT:



### POWERFUL CONTROL PANEL

- Control via Simatic PC IPC 427 E, Core i5
- Storage capacity: 250 GB (SATA)
- Data volume: 8 GB
- Operating system: Windows 10 IoT Enterprise 2019 (64 Bit)
- Equipped with 22" Widescreen monitor
- Memory capacity up to 10.000 tube geometries with 40 positions each
- Start and stop bending with buttons on the control panel
- Manual mode allows keyboard/mouse control of all functions



### SOFTWARE

Control software allows easy input of bending data and a detailed simulation of potential collisions.

### REMOTE DIAGNOSTICS

gives service technicians remote access to machine controls.

### FULLY ELECTRIC

100% electric drive of all 9 axes. Compared to hydraulic machines, energy savings of up to 50% can be achieved.

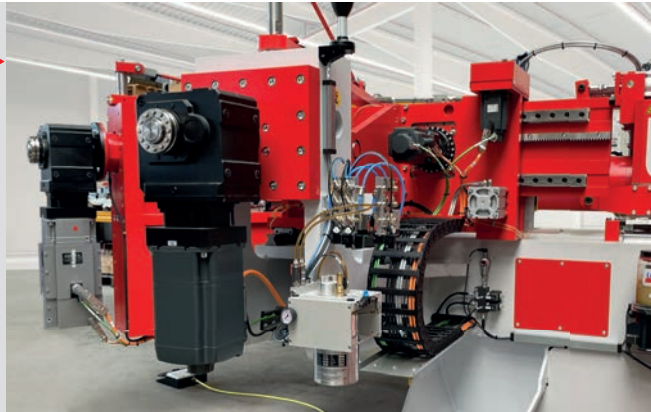

### AIR CONDITIONING

Protects the electrical cabinet even in hot and humid environments.

### CONTROL UNIT

The control unit is equipped with high-quality electronic components from leading suppliers. This ensures a long service life and a reliable supply of spare parts over a long period of time.



## BASIC EQUIPMENT:

### BENDING MANDRELS

available in different contours or materials.

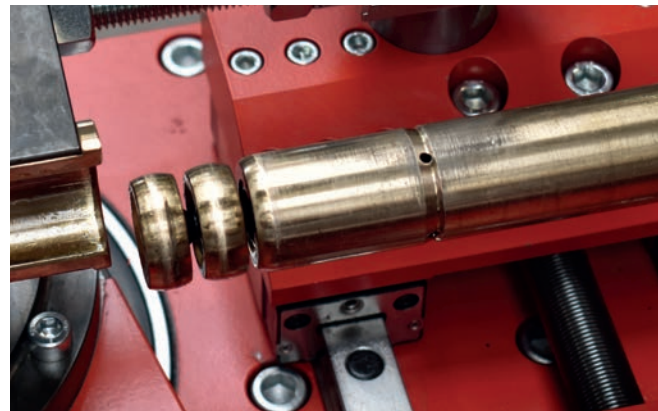
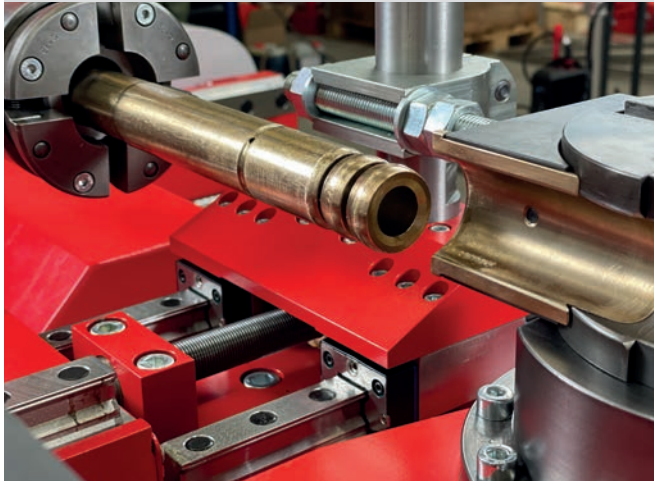
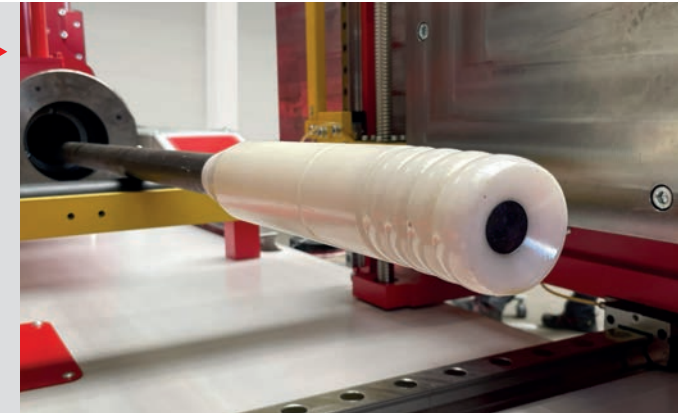
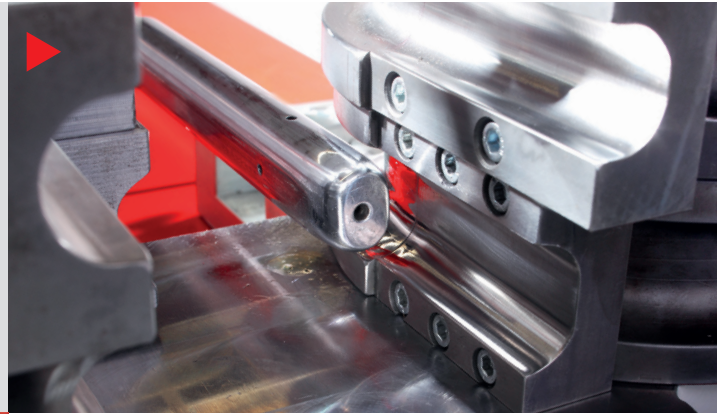

### AUTOMATIC MANDREL LUBRICATION

Available for inside diameters as small as  $\varnothing 13.5$  mm.  
Lubricant quantity can be easily adjusted and minimized.

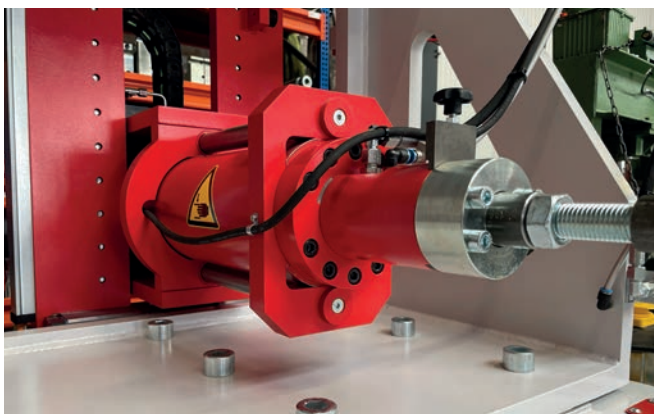

### MANDREL WITHDRAWAL

Automatic and programmable.

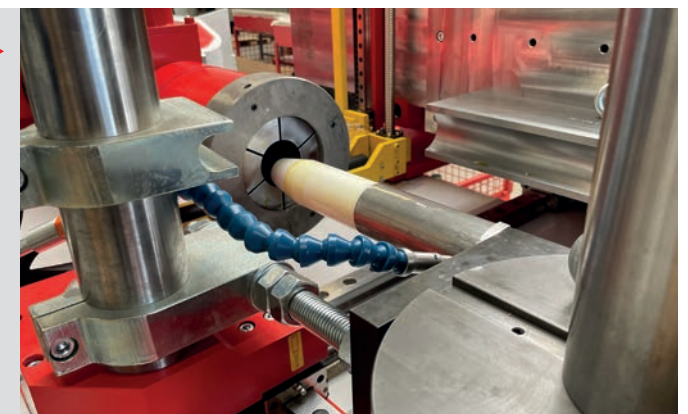



## BASIC EQUIPMENT:

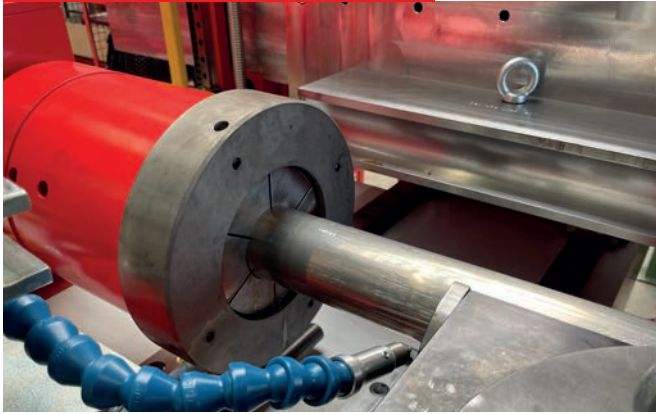

### CLAMPING

Material clamping in the collet is pneumatic

Forming your tube before bending? Custom clamps can be provided.



### FOOTSWITCH

Footswitch to open or close the collet for easy loading and unloading.

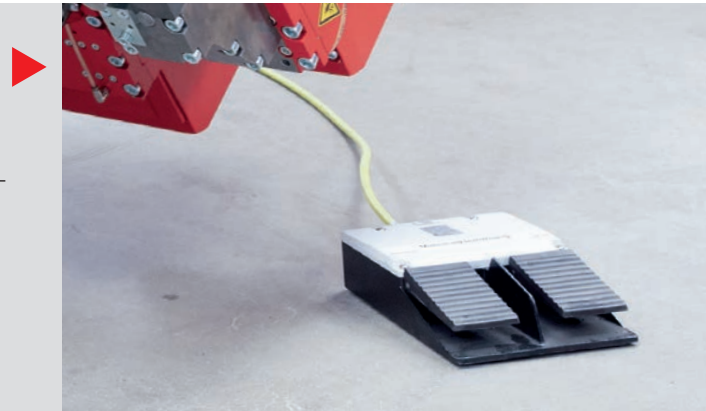

### FOLLOWING PRESSURE DIE

Following pressure die for bends up to 180° (for radii up to max. 2xD, for larger bending radii the pressure die can be repositioned to ensure a constant contact up to 180° bending angle).

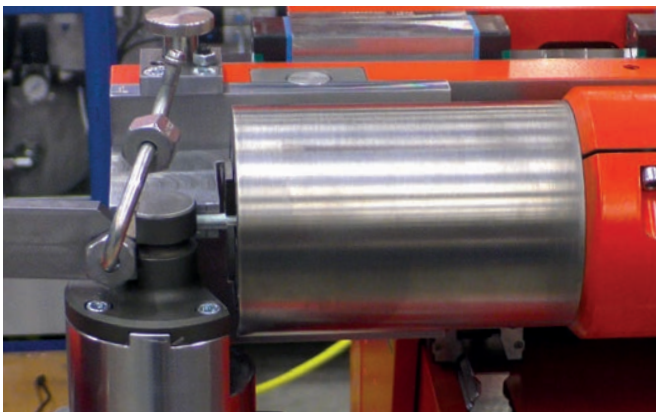

### PRESSURE DIE

The wide-opening pressure-die allows the collet to move directly behind the bend tool when tube ends are short.

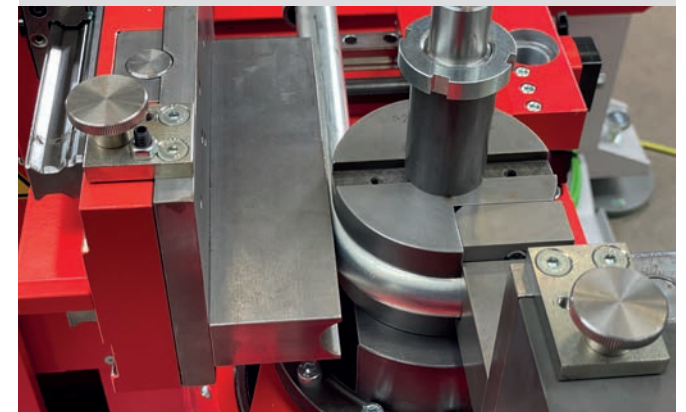

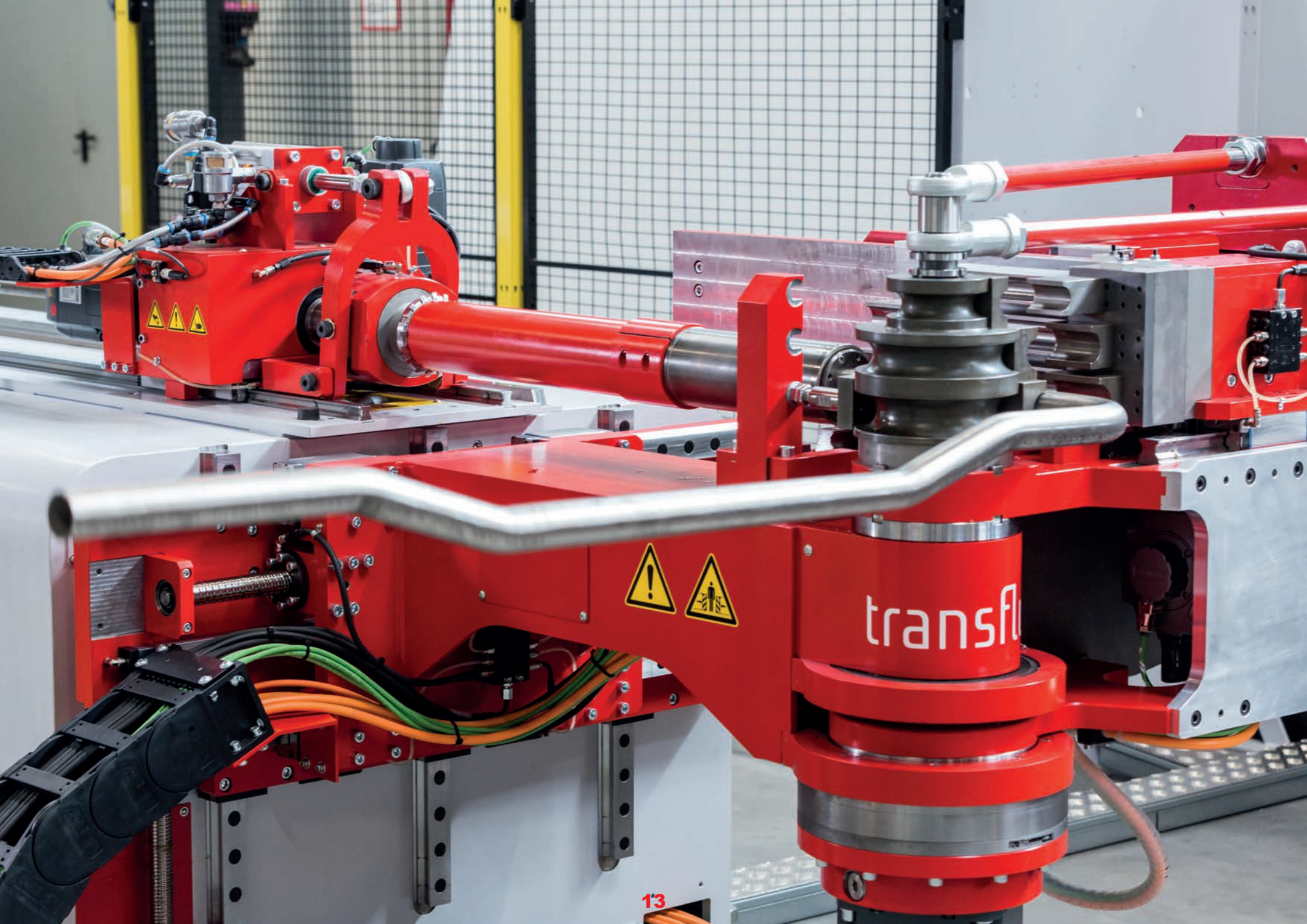

## OPTIONAL EQUIPMENT:

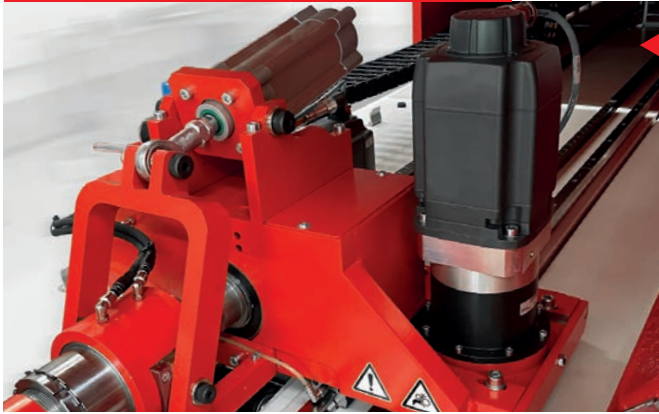

### BOOSTING FUNCTION

The collet is equipped with a powerful motor for push bending. Especially when bending thin-walled materials and very small bend radii this feature can improve the bend quality and the wall thinning can be reduced.

### PUSH BENDING

Special tooling is available for push bending large radii.



### REPEATED GRIPPING

For bending tubes exceeding the max. usable length of the machine and bent without mandrel

Bending with a mandrel is possible up to the maximum useable length of the machine plus approx. 1260 mm

Mechanical pneumatic length stop in the front of the collet.



### HAND SCANNER

For loading bending programs.

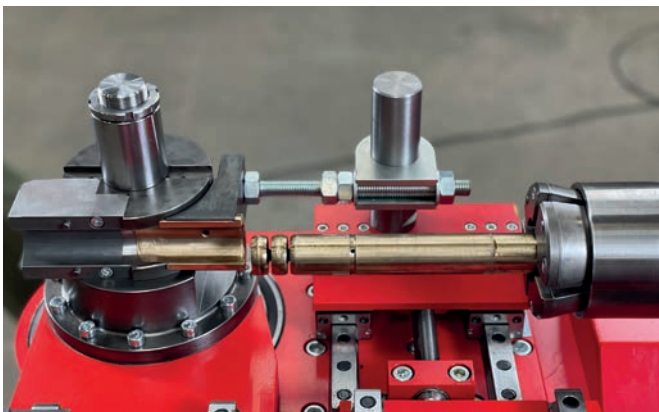
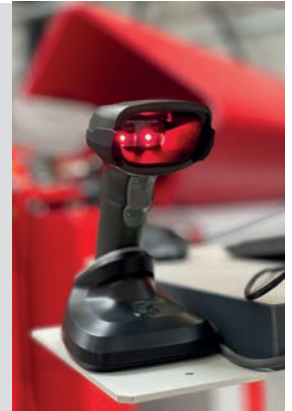

### ADJUSTABLE CARRIAGE FOR WIPER DIE

Prevents the deformation in the form of wrinkles that occurs when the material exceeds its elastic limit and sets in the curve.

### MANDREL SUPPORT

For a correct positioning of the mandrel, the machine is equipped with a mandrel support.



### SAFETY COVER

Safety guarding system consisting of an safety cover. The machine is built according to the latest safety regulations.

### SCANNER

Mounted below the bending head for CE-compliant securing of automatic machines typ DB-CNC. These are multi-area scanner, which in combination with t-project, can automatically manage up to 8 warning fields and adjust them, depending on the tube length.

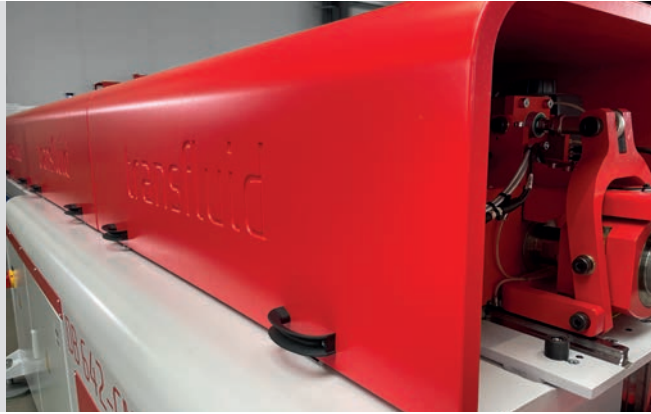

### AUTOMATED TOOL CHANGE

„Automatic clamping changer for bending very complex geometries (bow in bow)“

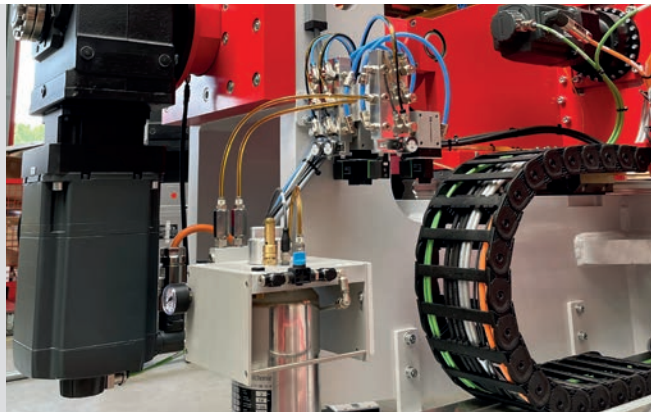

### CENTRAL LUBRICATION

For automaticall lubrication of all moving parts in the necessary cycle.

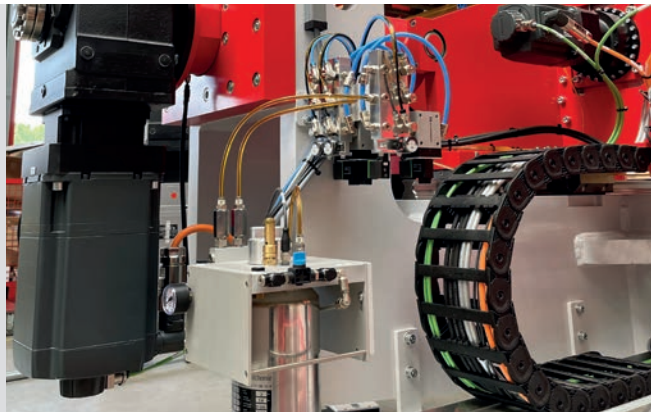

## OPTIONAL EQUIPMENT:



# LOADING & UNLOADING SYSTEMS DESIGNED AND MANUFACTURED BY TRANSFLUID®

We offer a great variety of loading systems for all the machines, depending on the material, tube diameter and tube length. Tubes that have already been formed and have added components can also be loaded without any issues. The appropriate orientation is therefore very important, when loading the tube into the production cell. External workpieces, such as nuts, flanges, supporting sleeves can be added to the system in a controlled manner and included in any subsequent processing steps. A great variety of loading volumes is possible.

## The right system for every need

For short tubes there are systems gripping from below with insertion axis. For long tubes, there are systems handling from above. Both options can be used in our combination systems. They guarantee ideal access for the operator, so they can complete the set-up and any maintenance operations in the best possible way.

All these systems are specially designed and produced by transfluid for our bending machines. This ensures optimal integration and functionality.

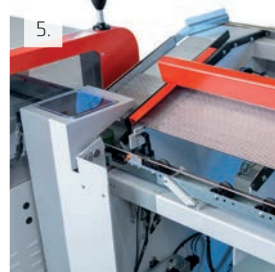
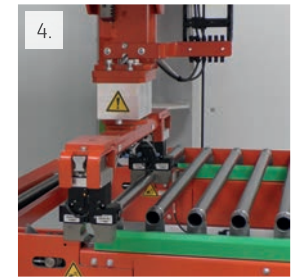
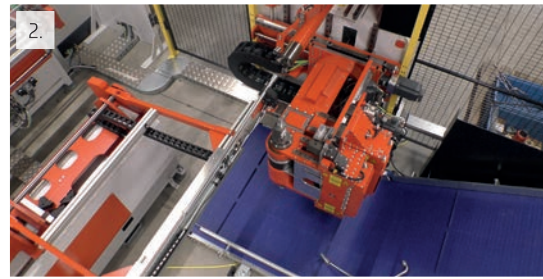

### LOADING SYSTEMS:

1. Alignment station
2. Swivel arm feeder
3. Step/belt feeding system
4. Chain feeder
5. Loading tables
6. Bowl feeder
7. Step feeder

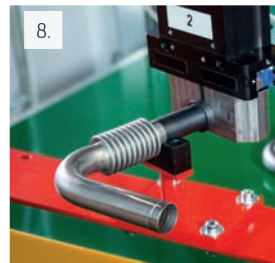
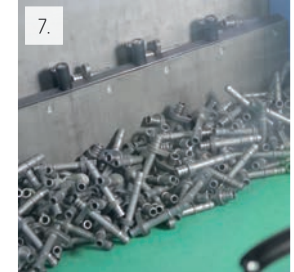
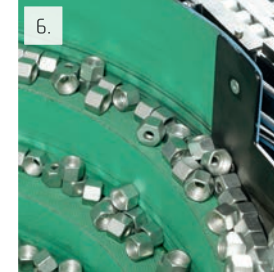

### HANDLING AND GRIPPER SYSTEMS:

8. Outer gripper
9. Handling robots
10. Rotating module
11. Overfloor handling
12. Linear handling
13. Underfloor handling
14. Inner and outer gripper

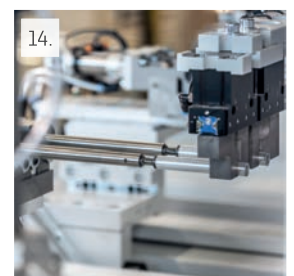
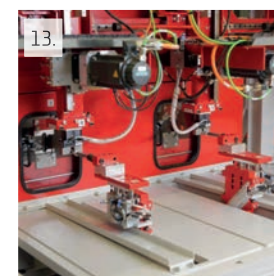
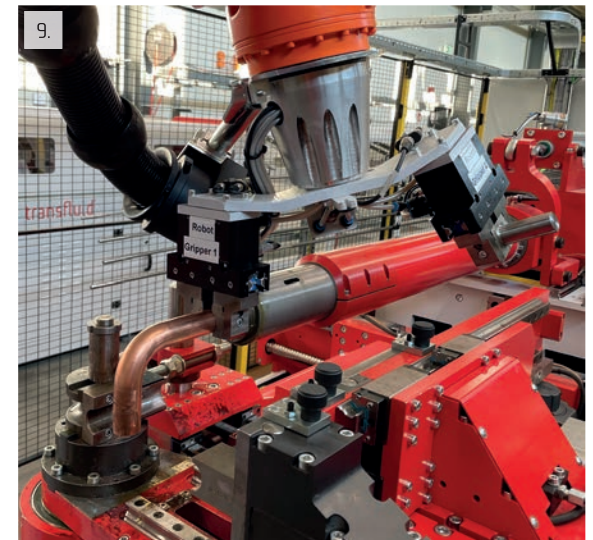





watch the  
movie

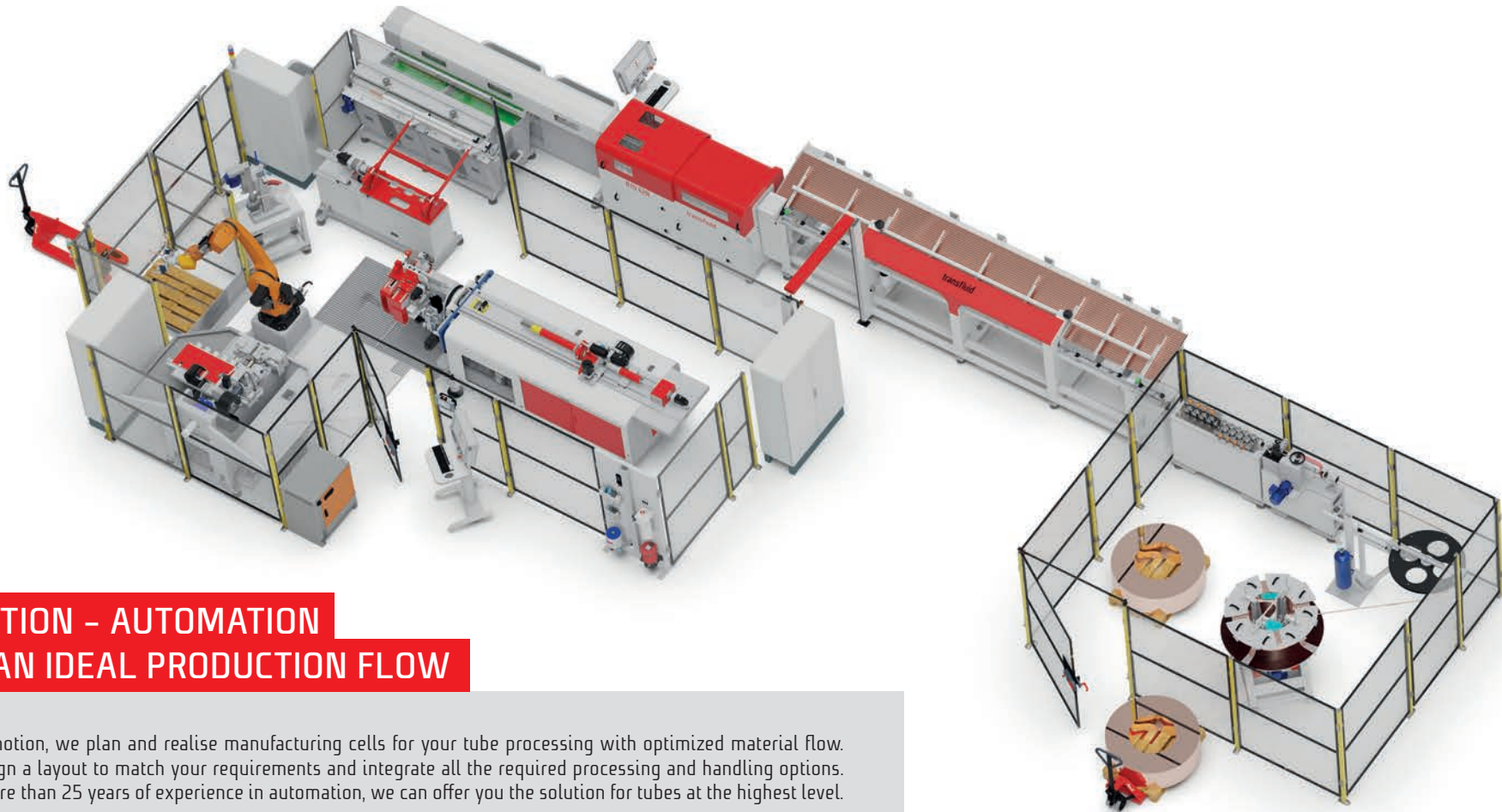

## T MOTION - AUTOMATION FOR AN IDEAL PRODUCTION FLOW

With t motion, we plan and realise manufacturing cells for your tube processing with optimized material flow. We design a layout to match your requirements and integrate all the required processing and handling options. With more than 25 years of experience in automation, we can offer you the solution for tubes at the highest level.

On request, we can add product marking, as well as optical, contactless camera control systems for comprehensive control of geometries or surfaces. The option to punch holes can also be integrated, as well as transfer lines to achieve the shortest possible cycle times, or systems for loading and controlled unloading, for your very own customised automation solution.

**Plug in and Produce** – With t motion you are production-ready from the start and flexible in batch production, without any delays.

**Customizable** – Further process steps, like loading and unloading systems or additional tube processing tasks can be integrated without any problems.

**Industry 4.0** – Interfaces with data caption systems for consumption and operation enable the digitalization and evaluation of the data.

**Fast and accurate** – The high degree of automation means fast cycle times and therefore efficient manufacturing.



Automotiv



Furniture



HVAC



Hydraulic





## T PROJECT - SOFTWARE: VIRTUAL SUPPORT FOR HIGHER EFFICIENCY

**Fewer steps to the finished workpiece:** With t project you can see all the variables of the bending process before starting the production. Even complex bending geometries can be planned and executed in a material-adapted and collision-free manner. The virtual bending simulation determines exact bending times and cutting lengths and checks tube geometries for feasibility in advance.

Tube data and bending results are documented with accuracy and they can then be replicated 100%. The common interfaces are available for the import and export of data and connection to PDA or ERP over the network.

### Our solution for your individual requirements

We have developed four versions of our t project software, which can be used as single or as networked versions. t project can be integrated centrally in the company's internal security system for optimum data security. Customer-specific modifications, expansions or interfaces are readily possible.

#### t project Basic

Input and calculation of tube processes

- Direct conversion of isometrics into bending data
- Automatically calculates correction values and over-bending parameters
- The dimension of the spatial diagonal from the beginning of the pipe A to the end of the pipe B enables the operator to easily check the bent part manually
- The software can interface with measuring devices and CAD and Office programs. Supported file formats include IGES, STEP, IT and PCF



#### t project Professional

Input and calculation of tube processes, including collision testing

- Same basic features as t project Basic
- Necessary tube length extensions are detected and added automatically
- Additional production safety: the collision test will determine the feasibility of the tube geometry before the actual bending process, which prevents collisions with the machine itself or its surroundings
- The software will suggest alternative options in case of predicted collisions
- The software will take all the measurements for the collision test from the CAD model of the bending machine
- Surrounding features in the room can also be included in the collision test (pillars, shelves, floor etc.)
- It is also possible to run simulations with tubes that already have flanges or other forming features.

#### t project Draft

Tablet version for mobile use

#### t project PM-N

Project management software



**transfluid®**  
**Maschinenbau GmbH**

Hünegräben 19-22  
D-57392 Schmallenberg  
Germany

Tel.: +49 29 72 / 97 15 - 0  
Fax.: +49 29 72 / 97 15 - 11

[info@transfluid.de](mailto:info@transfluid.de)  
[www.transfluid.net](http://www.transfluid.net)